



Control component Easy

for VAV terminal units

LVC • TVE • TVR • TVJ • TVT • TZ-/TA-Silenzio • TVZ • TVA



Read the instructions prior to performing any task!

TROX GmbH

Heinrich-Trox-Platz

47504 Neukirchen-Vluyn

Germany

Telephone: +49 (0) 2845 202-0

Fax: +49 (0) 2845 202-265

E-mail: trox@trox.de

Internet: www.troxtechnik.com

A00000073971, 2, GB/en

03/2020

© TROX GmbH 2018

General information

Information about installation and commissioning instructions

These installation and commissioning instructions enable the safe and efficient handling of the Easy type control components and the associated VAV terminal unit.

The manual must be kept near the unit to be available for use at all times.

The personnel performing work on the device must read and understand this manual carefully before starting any work. The basic prerequisite for safe working is to comply with the safety notes and all instructions in this manual.

In addition, the local health and safety regulations and general safety regulations apply to the area of application of the device.

Illustrations in this manual are mainly for information and may differ from the actual design.

Other applicable documentation

In addition to these instructions, the following documents must be observed:

- Installation and commissioning instructions of the VAV terminal unit
- Product data sheets
- Project-specific wiring documents, if any

TROX Technical Service

To ensure that your request is processed as quickly as possible, please keep the following information ready:

- Product name
- TROX order number
- Delivery date
- Brief description of the fault

Online	www.troxtechnik.com
Phone	+49 2845 202-400

Safety notes

Symbols are used in this manual to alert readers to areas of potential hazard. Signal words express the degree of the hazard.

Comply with all safety instructions and proceed carefully to avoid accidents, injuries and damage to property.

DANGER!

Imminently hazardous situation which, if not avoided, will result in death or serious injury.

WARNING!

Potentially hazardous situation which, if not avoided, may result in death or serious injury.

CAUTION!

Potentially hazardous situation which, if not avoided, may result in minor or moderate injury.

NOTICE!

Potentially hazardous situation which, if not avoided, may result in property damage.

ENVIRONMENT!

Environmental pollution hazard.

Tips and recommendations



Useful tips and recommendations as well as information for efficient and fault-free operation.

Safety notes as part of instructions

Safety notes may refer to individual instructions. In this case, safety notes will be included in the instructions and hence facilitate following the instructions. The above listed signal words will be used.

Example:

1. ▶ Loosen the screw.

2. ▶



CAUTION!



Danger of finger entrapment when closing the lid.

Be careful when closing the lid.

3. ▶ Tighten the screw.

Specific safety notes

The following symbols are used in safety notes to alert you to specific hazards:

Warning signs	Type of danger
	Warning – high-voltage.
	Warning – danger zone.

1	Safety	6	7.2	Systematic troubleshooting.....	28
	1.1 Correct use.....	6	7.3	Further diagnostic options.....	29
	1.2 Safety signs.....	6	7.3.1	Use of voltmeters to control setpoint values and feedback signals.....	29
	1.3 Residual risks.....	6	7.3.2	Use of adjustment devices.....	30
	1.3.1 Electric shock hazards.....	7	7.3.3	Adjustments sticker.....	30
	1.4 System owner's responsibility.....	7	7.3.4	Ordering replacement controllers.....	30
	1.5 Staff.....	7	8	Disposal	31
	1.6 Personal protective equipment.....	8	9	Technical data	32
	1.7 General safety measures.....	8	10	Declaration of conformity	35
	1.8 Repair and replacement parts.....	8			
2	Transport, storage and packaging	9			
	2.1 Delivery check.....	9			
	2.2 Transport on site.....	9			
	2.3 Storage.....	9			
	2.4 Packaging.....	9			
3	Structure and functional description	10			
	3.1 Product overview types LVC, TVR, TVJ, TVT, TZ-Silenzio, TA-Silenzio, TVZ, TVA..	10			
	3.2 Product overview TVE type.....	11			
	3.3 Position of the damper blade.....	11			
	3.4 Function description.....	12			
	3.5 Operating modes.....	13			
	3.5.1 Operation with constant volume flow rate setpoint value.....	13			
	3.5.2 Operation with variable volume flow rate setpoint value.....	14			
	3.6 Characteristics.....	16			
4	Installation	17			
5	Wiring	18			
	5.1 Installation instructions.....	18			
	5.2 Connection diagrams.....	18			
6	Commissioning and operation	21			
	6.1 Setting the Easy controller.....	21			
	6.1.1 Control ranges of VAV terminal units.....	22			
	6.1.2 Volume flow rate scale.....	22			
	6.1.3 Settings examples.....	23			
	6.1.4 Default settings V_{\min} and V_{\max}	24			
	6.1.5 Setting constant volume flow control.....	24			
	6.1.6 Setting variable volume flow control.....	24			
	6.2 Functional test.....	25			
	6.3 Switching the direction of rotation.....	25			
7	Troubleshooting	26			
	7.1 Common mistakes.....	26			
	7.1.1 Volume flow rate deviation due to unfav- ourable installation situation.....	26			
	7.1.2 Incorrect wiring.....	26			
	7.1.3 System pressure too low.....	26			
	7.1.4 Use outside the control area.....	26			
	7.1.5 Deviation between setpoint value and actual value signal.....	26			

1 Safety

1.1 Correct use

The electronic control component type Easy is used in combination with a TROX air terminal unit for variable volume flow rate control in ventilation and air conditioning systems.

The control components Easy (controller Easy for short) is designed for use indoors to control clean indoor air.

- Supply air area of application:
 - The usual conditioning in ventilation and air conditioning systems allows the use of the Easy controller in the supply air without additional dust protection measures.
- Extract air area of application:
 - Extract air with a low content of dust or lint (e.g. office) allows the use of the Easy controller without additional dust protection measures.
 - For dry extract air with a higher proportion of dust or lint, a suitable filter must be used in front of the VAV terminal unit.
 - For extract air with a high content of dust, lint or sticky components, or extract air with aggressive operating fluids, use a controller with a static differential pressure transducer, e.g. TROX Compact controller or universal controller.
 - Do not use VAV terminal units in extract air systems in commercial kitchens unless the extract air has been cleaned as much as possible with high-efficiency aerosol separators; see VDI 2052.

In unspecified applications, or when combined with polluted air (e.g. dust) and moisture, a controller with static differential pressure transducer should be used, e.g. TROX Compact controller or universal controller.

Incorrect use

WARNING!

Danger of injury or risk of damage to property due to incorrect use!

Misuse of the control component can lead to dangerous situations.

Never use the control component/device:

- in explosion-proof areas
- in aircraft
- outdoors without sufficient protection against the effects of weather
- in humid air (even temporarily, i.e. in wet areas, such as bathrooms with showers)
- for areas of application that are not described in this manual

Modifying the unit or using replacement parts that have not been approved by TROX is not permitted.

1.2 Safety signs

The following symbols and signs are usually found in the work area. They apply to the very location where they are found.

WARNING!

Danger due to illegible signage!

Over time, stickers and signs may fade or become otherwise illegible, meaning that hazards cannot be identified and necessary operating instructions cannot be followed. There is then a risk of injury.

- Ensure that all of the safety, warning and operating information is clearly legible.
- Replace illegible signs or stickers immediately.

Electrical voltage



Only skilled qualified electricians are allowed to work in areas marked as having electrical voltage.

Unauthorised people must not enter areas, open cabinets or work on components where an electrical voltage is present and which are hence marked with this symbol.

1.3 Residual risks

The VAV terminal unit is state of the art, and designed in accordance with current safety requirements. Residual risks cannot be excluded, however, and you should proceed with caution. This section describes the residual risks that have been identified in a risk assessment.

Always follow the safety notes in this manual to reduce health hazards and prevent any hazardous situations.

1.3.1 Electric shock hazards

Electric current

DANGER!

Danger of death due to electric current!

Danger of electric shock! Do not touch any live components! Damaged insulation or damaged parts are a life threatening hazard.

- Have work on the electrical system carried out only by skilled qualified electricians.
- If the insulation is damaged, disconnect the power supply immediately and have the insulation repaired.
- Before you start working on electric systems and equipment, switch off the supply voltage and secure it against being switched on accidentally. Comply with the following safety rules:
 - Switch off the power supply.
 - Secure it against being switched on accidentally.
 - Ensure that no voltage is present.
 - Connect to the earth; short circuit connection.
- Do not bypass or disable any circuit breakers. Be sure to maintain the correct current rating when you replace a circuit breaker.
- Ensure that live parts do not come into contact with moisture. Moisture can cause a short circuit.

1.4 System owner's responsibility

System owner

The system owner is a natural or legal person who for commercial or business purposes owns or manages the ventilation system or component or allows third parties to use or operate it, but continues to bear legal responsibility for the safety of users, staff or third parties while the product is in use.

System owner's obligations

The unit is intended for commercial use. The system owner is therefore subject to the legal obligations of occupational health and safety regulations.

In addition to the safety notes in this manual, the applicable regulations for safety, accident prevention and environmental protection must also be complied with.

In particular:

- The system owner must be aware of the applicable occupational health and safety regulations and carry out a risk assessment to determine any additional hazards that may exist or result from the specific working conditions at the installation location. The system owner has to create operating instructions for the unit that reflect the results of this risk assessment.
- The system owner has to ensure, throughout the entire operating period of the unit, that these operating instructions conform to applicable standards and guidelines; in case of any deviation, the system owner has to adapt the instructions.
- The system owner must secure the unit to prevent access by unauthorised individuals.
- The system owner must clearly define the responsibilities for operation, maintenance, cleaning, troubleshooting and removal.
- The system owner has to ensure that all individuals who handle or use the unit have read and understood this manual.
- The system owner must provide the employees with the required personal protective equipment.
- The system owner must observe the local fire regulations.

Hygiene requirements

The system owner has to comply with the local regulations and harmonised standards for hygiene requirements. These include, among other things, compliance with the corresponding maintenance and test intervals.

1.5 Staff

Qualification

The work described in this manual has to be carried out by individuals with the qualification, training, knowledge and experience described below:

HVAC technician

HVAC technicians are individuals who have sufficient professional or technical training in the field they are working in to enable them to carry out their assigned duties at the level of responsibility allocated to them and in compliance with the relevant guidelines, safety regulations and instructions. HVAC technicians are individuals who have in-depth knowledge and skills related to HVAC systems; they are also responsible for the professional completion of the work under consideration.

HVAC technicians are individuals who have sufficient professional or technical training, knowledge and actual experience to enable them to work on HVAC systems, understand any potential hazards related to the work under consideration, and recognise and avoid any risks involved.

Skilled qualified electrician

Skilled qualified electricians are individuals who have sufficient professional or technical training, knowledge and actual experience to enable them to work on electrical systems, understand any potential hazards related to the work under consideration, and recognise and avoid any risks involved.

TROX Technical Service

Staff of TROX Technical Service or of service partner companies approved and assigned by TROX GmbH.

1.6 Personal protective equipment

Personal protective equipment is equipment that protects the user against health or safety risks at work.

Personal protective equipment must be worn for various types of work; the protective equipment required is listed in this manual together with the description of each type of work.

Description of personal protective equipment

Industrial safety helmet



Industrial safety helmets protect the head from falling objects, suspended loads, and the effects of striking the head against stationary objects.

Protective gloves



Protective gloves protect hands from friction, abrasions, punctures, deep cuts, and direct contact with hot surfaces.

Safety shoes



Safety shoes protect the feet from crushing, falling parts and prevent slipping on a slippery floor.

1.7 General safety measures

! NOTICE!

Risk of damage to property due to large temperature differences

If any electronic components have been kept in an unheated area, condensation may form and damage the electronic components beyond repair.

- Before you start commissioning, make sure that all devices have warmed up to ambient temperature. Only after about 2 hours will the system have reached room temperature.

Foreign matter and liquids

! NOTICE!

Risk of damage to property due to foreign matter and liquids!

Foreign matter and liquids that get into the unit may damage the electronic parts.

- Do not use any liquids for cleaning.
- Remove foreign matter, if any.
- If the device emits a smell or smoke, have it checked by the manufacturer.
- If liquid gets into the module, let the module completely dry before commissioning.

1.8 Repair and replacement parts

Only qualified personnel are allowed to repair the devices, and only genuine replacement parts are allowed to be used. This applies in particular to work on the electrical equipment. Therefore, for safety reasons, have defective devices repaired by TROX Technical Service, ☎ 'TROX Technical Service' on page 3.

2 Transport, storage and packaging

Sharp edges and sheet metal parts

 **CAUTION!**

Danger of injury from sharp edges and sheet metal parts.

- Always wear protective gloves when handling the unit.

Damage to the VAV terminal unit

 **NOTICE!**

Risk of damage to the VAV terminal unit!

- Handle the unit with care.
- Do not lift the VAV terminal unit by its control components, the damper blade or differential pressure sensor.
- Lift the unit only by lifting the entire casing.

2.1 Delivery check

Check delivered items immediately after arrival for transport damage and completeness. In case of any damage or an incomplete shipment, contact the shipping company and your supplier immediately.

The delivery is typically completed mounted on a VAV terminal unit.

Check the following items on delivery:

- Easy controller
 - Transparent protective cap, or for TVE-type rubber terminal covers.
 - mounted on the VAV terminal unit and fixed with anti-rotation lock
 - Measuring hoses without kinks connected to the VAV terminal unit (not with TVE type)
- VAV terminal unit:
 - Scale sticker available for setting V_{\min}/V_{\max}
 - Adjustments sticker available
 - Cable ties for wire clamping bracket available (not for TVE type)

2.2 Transport on site

- If possible, transport the VAV terminal unit to the installation location in the shipping container.
- Do not remove the protective wrapping until just before installation.

2.3 Storage

If the product has to be stored temporarily:

- Moisture and lack of ventilation can lead to oxidation, even on galvanised components. Remove any plastic wrapping in order to avoid oxidation.
- Protect the product from dust and contamination.
- Store the product in a dry place and away from direct sunlight.
- Do not store the product below -10 °C or above +50 °C.

2.4 Packaging

Properly dispose of packaging material.

3 Structure and functional description

3.1 Product overview types LVC, TVR, TVJ, TVT, TZ-Silenzio, TA-Silenzio, TVZ, TVA

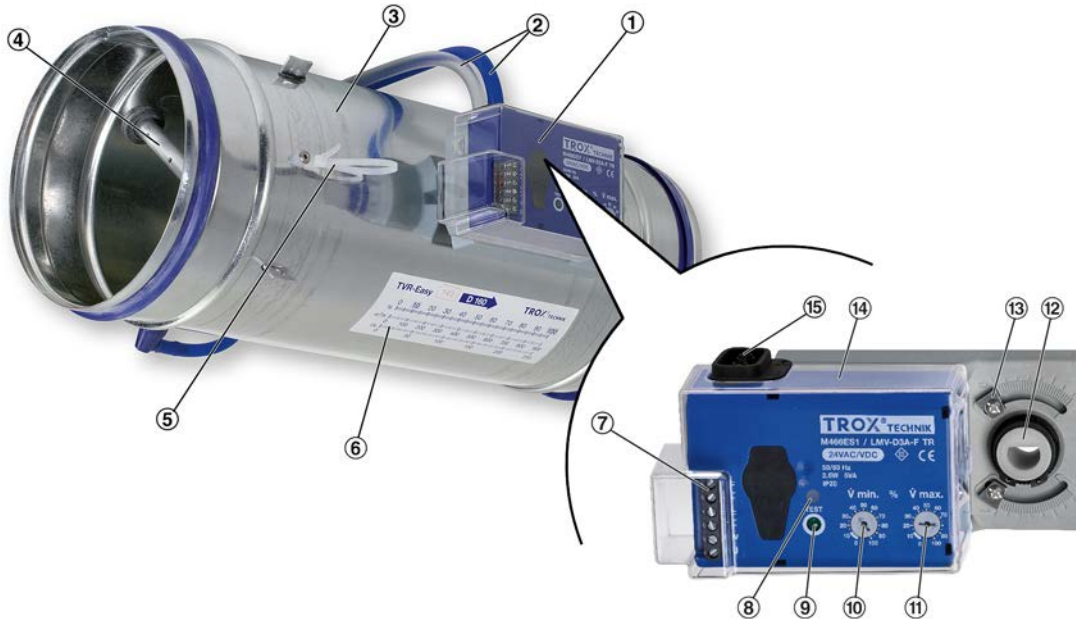

Fig. 1: Easy controller mounted on the control unit e.g. TVR

- | | |
|---|---|
| 1 Easy controller | 9 LED for displaying the operating states, see table |
| 2 Test hoses | 10 V_{\min} potentiometer |
| 3 VAV terminal unit | 11 V_{\max} potentiometer |
| 4 Sensor tubes of the control unit | 12 Axle mounting (positive connection or clamping device) |
| 5 Strain relief | 13 Travel stops |
| 6 Scale sticker for setting V_{\min}/V_{\max} | 14 Protective cap |
| 7 Terminals | 15 Tube connection transducer |
| 8 'Test' push button | – Adjustments sticker on VAV terminal unit (not pictured) |

Detection of operating states (LED)

LED	Operating status
On	Target volume flow rate reached
Off	<ul style="list-style-type: none"> ■ Test push button pressed ■ No supply voltage ■ Easy controller faults
Flashes (slowly 0.5 Hz)	<ul style="list-style-type: none"> ■ Actual value \neq setpoint value, controller tries to control to the setpoint value ■ Test operation started ■ Synchronisation process active
Flashes (rapidly 2.5 Hz)	Direction of rotation change confirmation ↪ Chapter 6.3 'Switching the direction of rotation' on page 25); Then slowly flashing until the synchronisation process is completed.

3.2 Product overview TVE type

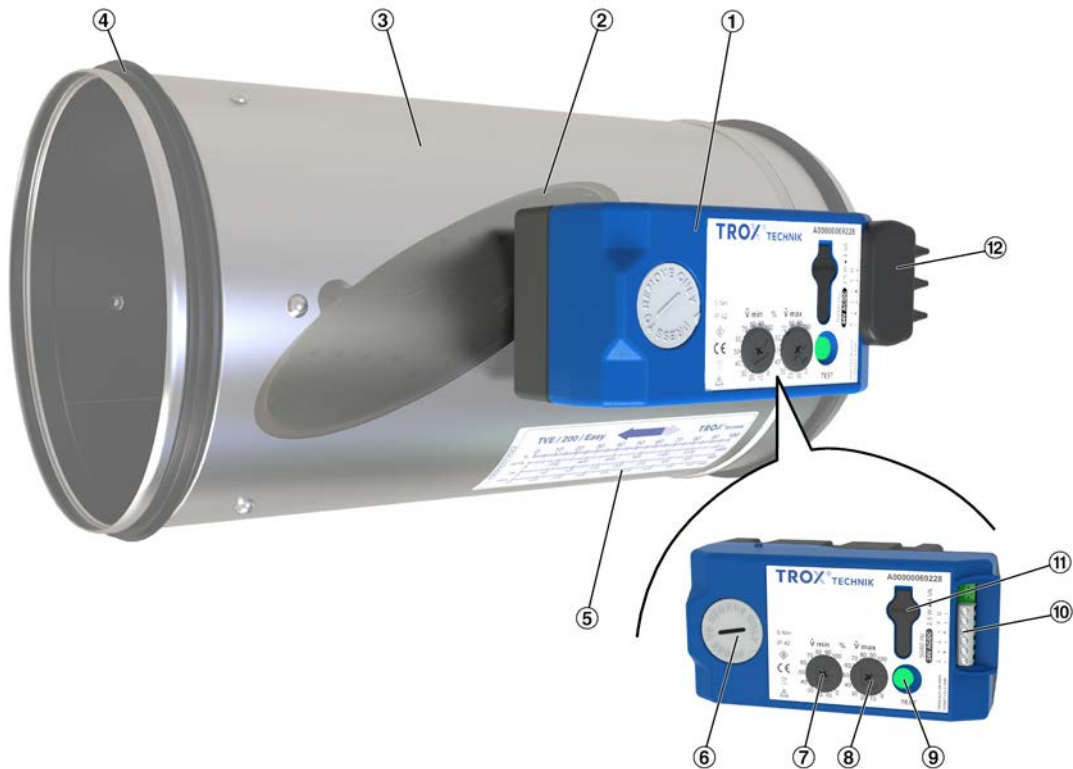

Fig. 2: TVE basic unit with Easy controller

- 1 Easy controller
- 2 Damper blade
- 3 VAV terminal unit
- 4 Lip seal
- 5 Scale sticker for setting V_{min}/V_{max}
- 6 Release button and damper blade position indicator
- 7 V_{min} potentiometer
- 8 V_{max} potentiometer
- 9 Test push button and LED to display the operating states, see table
- 10 Terminals
- 11 Service socket
- 12 Cover of the terminals
- Adjustments sticker on VAV terminal unit (not pictured)

Detection of operating states (LED) TVE type

LED flashing frequency	Meaning
	No supply voltage
	Controller not parameterised
	Actuator overload detected (block)
	Positive pressure detected on effective pressure sensor
	Synchronisation or test mode activated

LED flashing frequency	Meaning
	Setpoint value or override control position not yet reached (0.5 Hz flashes)
	Control mode setpoint value corrected

3.3 Position of the damper blade

The position of the damper blade corresponds to the mark on the axis and is thus recognisable from the outside.

Positive lock connection

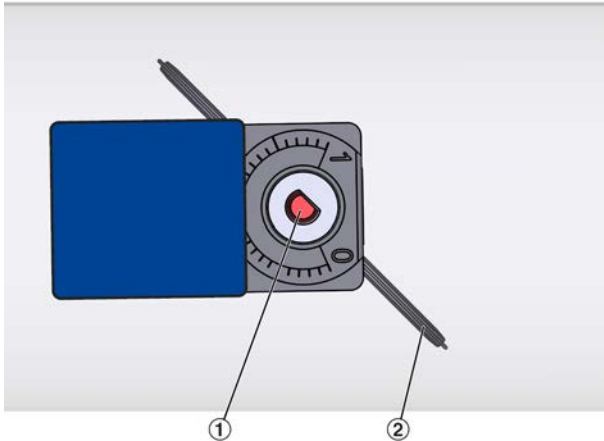

Fig. 3: Controller with lock connection

- 1 Shaft with marking for position indication
- 2 Damper blade

Clamping device (frictional connection)

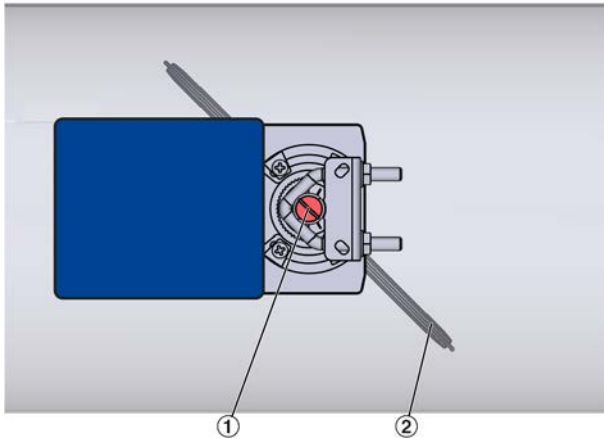

Fig. 4: Controller with clamping device

- 1 Shaft with marking for position indication
- 2 Damper blade

TVE

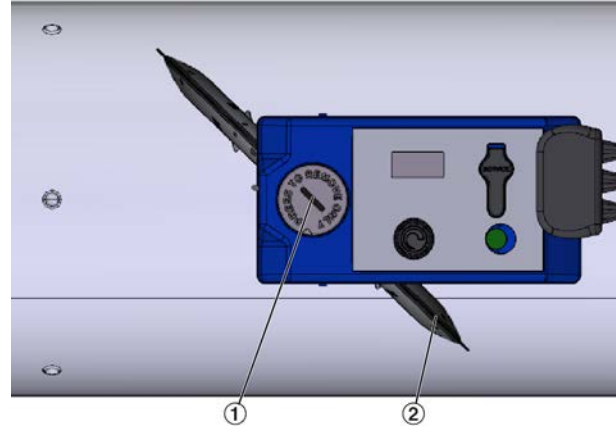

Fig. 5: TVE controller

- 1 Shaft with marking for position indication
- 2 Damper blade

3.4 Function description

Basic function

The Easy controller is an electronic control component for variable volume flow control for various TROX VAV terminal units. Its functional units consist of a dynamic differential pressure transducer, the controller electronics and the actuator.

Closed control circuit

The controller operates in closed loop, i.e. to measure – compare – control.

The determination of the current volume flow rate takes place by measuring a differential pressure (effective pressure). For this purpose, the air terminal unit has a differential pressure sensor. The effective pressure is forwarded through the measuring hoses or, in the case of TVE, through the damper blade shaft to the differential pressure transducer integrated in the control component and converted here into a voltage signal.

The volume flow rate actual value is thus the internal control loop as well as an external use, e.g. BMS or master-slave sequential circuit, available as analogue voltage signal 0-10 V. Due to the factory adjustment, the maximum output value of 10 V DC always corresponds to the nominal volume flow rate (V_{nominal}) which can be taken from the scale sticker and the adjustments sticker on the VAV terminal unit.

The nominal volume flow rate is either set as a constant value or specified by an analogue voltage signal at the setpoint value input. The definition of the constant volume flow rates or of the working range for variable operation is carried out by the customer at the potentiometers V_{min} and V_{max} .

In regular operation, the integrated actuator is controlled by permanent evaluation of the offset (setpoint value-actual) that adjusts the damper blade of the air terminal unit via the axle mounting and thus regulates the volume flow rate to the setpoint value.

Setpoint value adjustment independent of the duct pressure

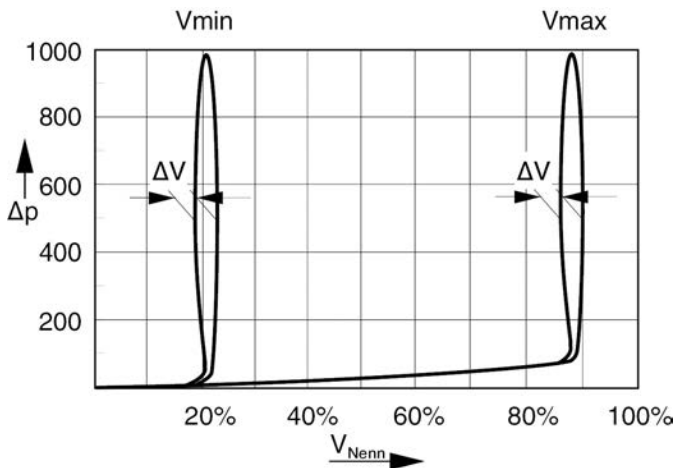

Fig. 6: Pressure independent control characteristics

The controller detects and corrects changes of the duct pressure that may occur, for example, due to volume flow rate changes from other units. The Easy controller thus operates duct pressure independently and pressure fluctuations result in no permanent changes in volume flow rate.

In order to prevent the volume flow control from becoming unstable, the controller maintains a dead band (hysteresis) within which the damper blade is not moved. This dead band and the tolerances of the measurement location lead to a volume flow rate deviation ΔV in accordance with the product data sheets of the VAV terminal units. If the conditions specified in the product data sheets (e.g. minimum differential pressure, upstream conditions) are not met, greater deviations are to be expected.

Diagnostic options

A function test is possible by means of test push button (Fig. 1/8) and LED indicator light (Fig. 1/9). The LED makes it possible to distinguish between operating and fault states.

The diagnosis of setpoint value and actual value signals is possible via voltmeter, [Chapter 7.3.1 'Use of voltmeters to control setpoint values and feedback signals' on page 29](#).

Adjustment devices cannot be used for Easy controllers, [Chapter 7.3.2 'Use of adjustment devices' on page 30](#).

3.5 Operating modes

3.5.1 Operation with constant volume flow rate setpoint value

Operation with a fixed setpoint value

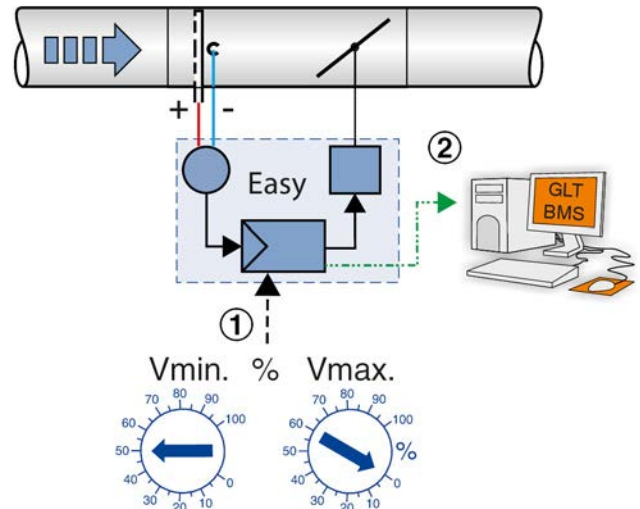

Fig. 7: Constant control

- 1 Volume flow rate setpoint value specification (V_{min})
- 2 Actual value volume flow rate as 0–10 V DC signal, e.g. to the central BMS

In the simplest case, the controller is operated with a constant volume flow rate setpoint value specification. During commissioning, the setpoint value is set directly on the rotary potentiometer (V_{min}) on the Easy controller ($V_{max} = 0\%$).

A control signal at terminal w is not required in this case.

Operation with two setpoint values (min./max. switching)

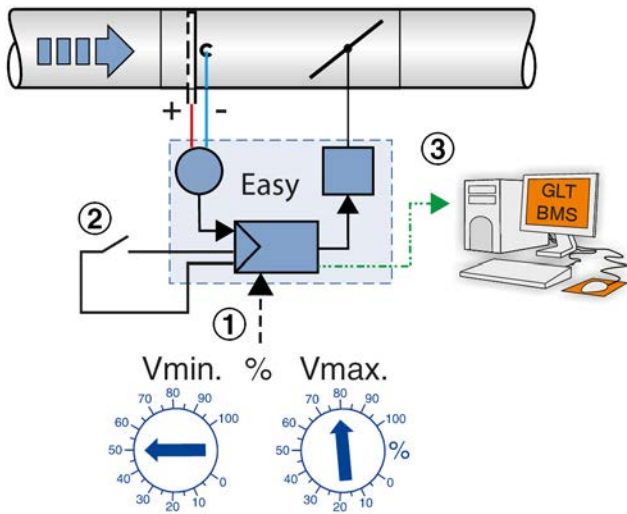

Fig. 8: Min./max. switching

- 1 Volume flow rate setpoint value specification (V_{\min} und V_{\max})
- 2 Switch or relay for switching between V_{\min} and V_{\max}
- 3 Actual value volume flow rate as 0–10 V DC signal, e.g. to the central BMS

The constant values (V_{\min} and V_{\max}) set on the rotary potentiometer can be activated alternately by volt-free switch contacts. Switching is accomplished by switches or relays, e.g. day/night switching.

3.5.2 Operation with variable volume flow rate setpoint value

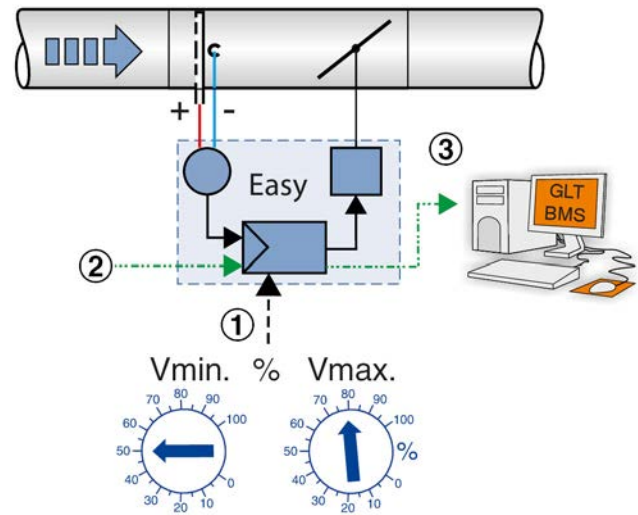

Fig. 9: Variable volume flow control

- 1 Volume flow rate limit value specification (V_{\min} and V_{\max})
- 2 Control signal 0–10 V DC at terminal w as setpoint value input, e.g. from room temperature controller or DCC outstation or similar.
- 3 Actual value volume flow rate as 0–10 V DC signal, e.g. to the central BMS

For the use of variable volume flow rate setpoint values, the specification of an electrical control signal must be made by a higher-level controller (e.g. room temperature controller, air quality controller, central building management system, etc.). If the input signal is changed, the controller adjusts the volume flow rate to the new setpoint. The variable volume flow rate is limited to a minimum and maximum volume flow rate value, see Chapter 3.6 'Characteristics' on page 16.

Override control

The constant or variable control can be disabled by override controls, e.g. when the window is open, a window switch stops ventilation of the room by closing the damper blade.

Further application examples:

- Circuits for quick ventilation (V_{\max})
- Opening the damper blade

Supply/extract air tracking control

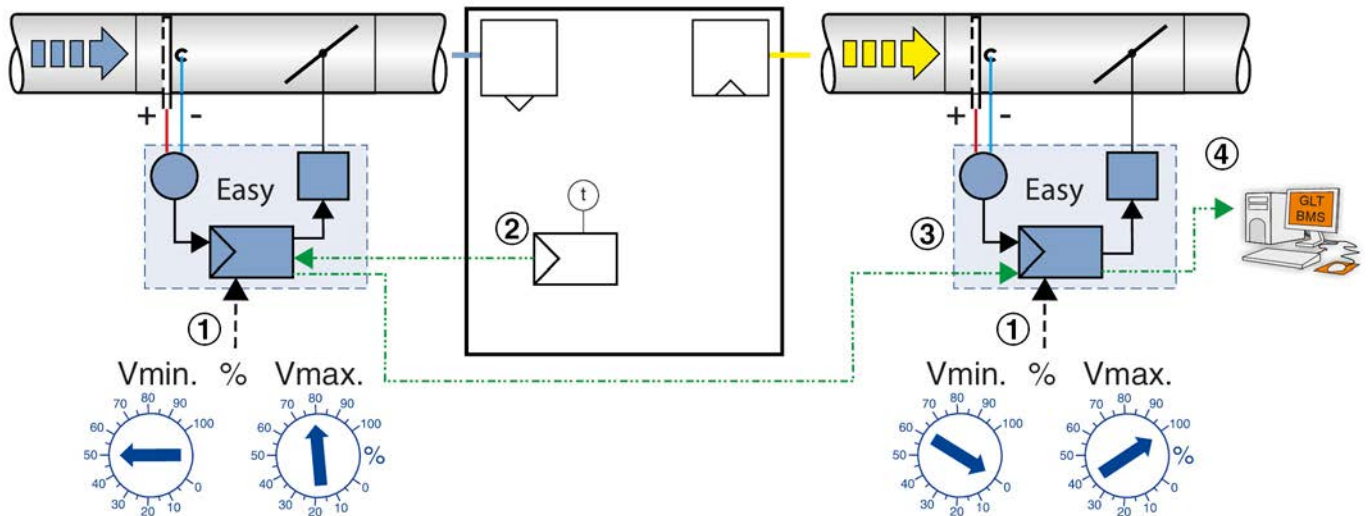

Fig. 10: Supply/extract air tracking control

- | | | | |
|---|--|---|---|
| 1 | Volume flow rate limit specification (V_{\min} and V_{\max}) | 3 | Actual value volume flow rate as 0–10 V DC signal to the extract air controller |
| 2 | Room temperature controller (control signal for supply air controller) | 4 | Actual value volume flow rate as 0–10 V DC signal, e.g. to the central BMS |

In individual rooms and closed-off office areas, where the balance between supply and extract air flow rate has to be maintained. Otherwise, annoying whistling noises can occur at door gaps, and the doors can be difficult to open. For this reason, the extract air should also have variable control in a VAV system.

The control signal from the room temperature controller is switched to the supply air controller in this example. The actual value signal of the Easy controller for the supply air is then applied as a setpoint signal for the Easy controller on the extract air (slave controller). As a consequence, the extract air always follows the supply air.

Setting for the slave controller in the simplest case (same VAV terminal units and dimensions):

- V_{\min} 0%
- V_{\max} 100%

When using different air terminal unit types or dimensions for tracking control, special setting instructions for V_{\min} and V_{\max} of the slave controller must be observed due to the different nominal volume flow rates.

Alternatively, the control signal of the room temperature controller can also be connected in parallel to the supply air and the extract air controller. The limitation due to the technical data of the controller outputs (current) and the controller inputs (input resistances) must be observed.

3.6 Characteristics

Actual value signal

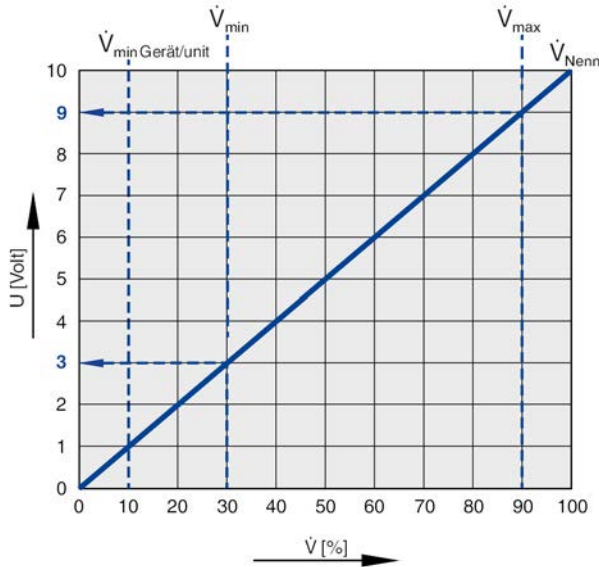

Fig. 11: Characteristic of the actual value signal 0–10 V

The actual value volume flow rate can be tapped as a voltage signal at the terminal (U). The measuring range is factory-adjusted to the size of the VAV terminal unit, so that the respectively rated nominal volume flow rate (\dot{V}_{Nom}) always corresponds to an actual value signal of 10 V DC. The current actual value volume flow rate can be calculated from the measured voltage at the output (U) using the formula below.

$$\dot{V}_{\text{Ist}} = \frac{U}{10} \dot{V}_{\text{Nenn}}$$

Setpoint value signal

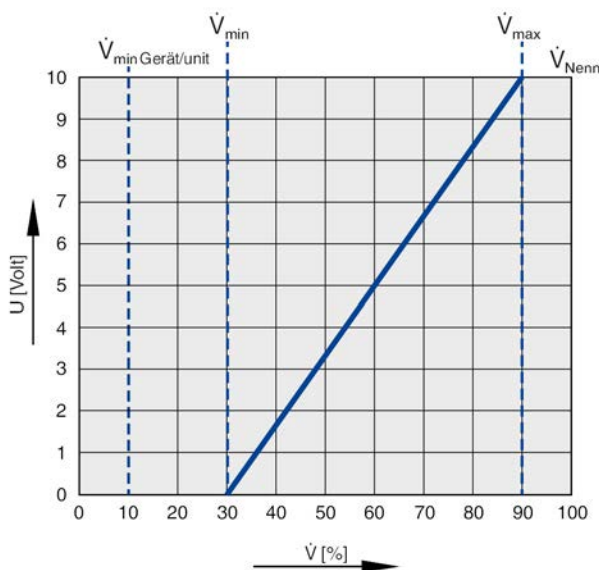

Fig. 12: Characteristic of the reference signal 0–10 V

In order to specify a volume flow rate setpoint value to the Easy controller, a DC voltage signal in the range of 0–10 V DC must be applied to terminal (w).

The relationship between the nominal volume flow rate and the associated voltage signal can be calculated from the formula below. The setting of the potentiometers V_{min} and V_{max} must be taken into account.

$$\dot{V}_{\text{Soll}} = \frac{W}{10} (\dot{V}_{\text{max}} - \dot{V}_{\text{min}}) + \dot{V}_{\text{min}}$$

The default settings of the working range $V_{\text{min}} = 40\%$ and $V_{\text{max}} = 80\%$ can be easily changed by the customer.

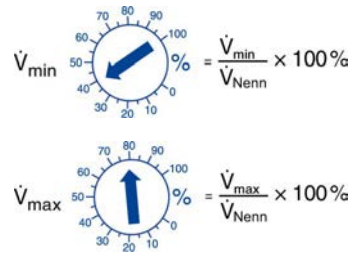

Calculation example:

- V_{nom} of the VAV terminal unit: - 800 m³/h
- V_{min} : - should be 200 m³/h
- V_{max} : - should be 600 m³/h

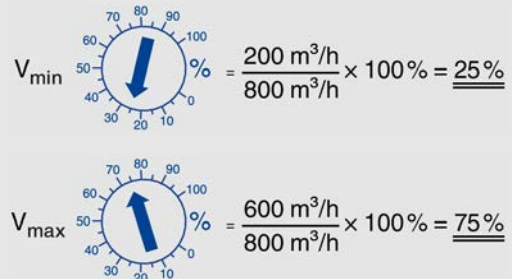

At a setting of $V_{\text{min}} = 0\%$ and $V_{\text{max}} = 100\%$, the controlling unit can specify the entire nominal volume flow rate range of the VAV terminal unit as a setpoint value.

If V_{min} and V_{max} are set to only a partial range of the nominal volume flow rate range; a higher resolution for the control input signal is available for this work area. In the first case, the limitation of the setpoint signal to the work area must be taken into account by the superordinate rule instance, see Chapter 6.1.1 'Control ranges of VAV terminal units' on page 22.

4 Installation

Personnel:

- HVAC technician

Protective equipment:

- Protective gloves
- Safety shoes
- Industrial safety helmet

Only specialist personnel are allowed to perform the described work on the VAV terminal unit.

Only skilled qualified electricians are allowed to work on the electrical system.

CAUTION!

Danger of injury from sharp edges and sheet metal parts.

- Always wear protective gloves when handling the unit.

The Easy controller is delivered mounted on the VAV terminal unit, so that the work is limited to the electrical wiring ↻ *Chapter 5 'Wiring' on page 18* and to the setting of the Easy controller ↻ *6.1 'Setting the Easy controller' on page 21*.

When installing the VAV terminal unit, take particular note of the following points:

- Upstream section
- Direction of airflow
- Fixing/suspension
- Accessibility for service work

Information on this can be found in the VAV terminal unit installation and commissioning instructions.

Installation orientation

The installation orientation of the VAV terminal unit is arbitrary due to the dynamic differential pressure transducer in the Easy controller. The Easy controller must be located on, under or to the side of the ductwork.

5 Wiring

Safety instructions

DANGER!

Danger of electric shock! Do not touch any live components! Electrical equipment carries a dangerous electrical voltage.

- Only skilled qualified electricians are allowed to work on the electrical system.
- Switch off the power supply before working on any electrical equipment.

5.1 Installation instructions

The VAV terminal unit was manufactured and configured on a project-specific basis. The control components are factory-mounted and balanced. For installation, the supply voltage and, if necessary, signal lines, must be connected for electrical control components.

The connection is made according to the information given on the control components or connection diagrams in this manual. These must be observed for project-specific wiring diagrams. The voltage ranges and the terminal connections specified on the control components must be observed!

Personnel:

- Skilled qualified electrician

Please note during installation:

- Legal and official regulations, in particular VDE guidelines.
- Consideration of the technical connection rules (TCR) of the local network operators.
- Wiring work for supply voltage and signal lines on site.
- The dimensioning and manufacture of customer-side connections and wiring must be carried out in accordance with the recognised rules of electrical engineering.
- Observe wiring guidelines and project-specific connection diagrams of the control component.
- The electrical connection to the control unit may only be made if the installation has been carried out correctly.
- The 24 V supply voltage may only be supplied with a safety transformer.
- In order to protect against overload, the supply voltage for a maximum of three Easy controllers may be through-wired.
- If several volume flow controllers are connected to a 24 V network, it must be ensured that a common neutral or ground line is defined and not interchanged.

- The control component contains no parts that can be replaced or repaired by the user and may only be opened by the manufacturer.
- Remove the transparent protective cap of the Easy controller only temporarily for wiring and commissioning, not available for TVE.
- For TVE type only: to ensure IP protection, use the rubber cover to insert the connection cables.
- Lay connecting cables in such a way that they cannot be accidentally damaged by mechanical impact or by heat.

Electrical safety

The Easy controller fulfills all relevant standards and guidelines. (See appendix for manufacturer's declaration).

Open terminals

According to the electro-technical regulations, contact protection insulation is only required for active parts.

Because Easy controllers are operated with protective extra-low voltage (PELV), the screw terminals are not considered active parts.

Wire clamping bracket

Devices that are permanently installed in buildings are stationary electrical equipment for which no wire clamping bracket on the connecting cables is prescribed.

Some VAV terminal units come with a wire clamping bracket (cable tie) that can be used to secure the connecting cable as part of electrical installation work.

5.2 Connection diagrams

Terminals

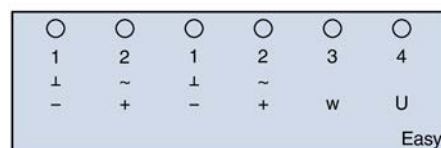

Fig. 13: Terminals

- 1 Ground
- 2 24 V AC / DC supply voltage
- 3 Reference signal (w) 0–10 V DC
- 4 Actual signal (U) 0–10 V DC

The connection terminals for the supply voltage (1 and 2) are doubled for easy rewiring.

Caution: to protect against overload, the supply voltage for a maximum of three Easy controllers must be through-wired.

Terminals for 0.5 to 2.5 mm² cables, rigid and flexible, AWG 22–10

Control constant volume flow rate V_{min}

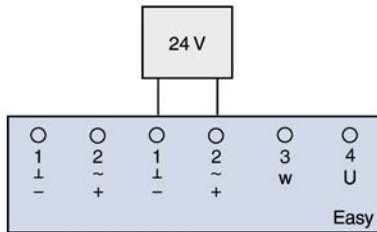

Fig. 14: Constant volume flow rate V_{min}

After applying the supply voltage 24 V, the controller throttles the volume flow rate to the value set on the V_{min} potentiometer. A setpoint signal is not required. The current actual value volume flow rate can be tapped at the terminal (U).

Variable volume flow control $V_{min} \dots V_{max}$

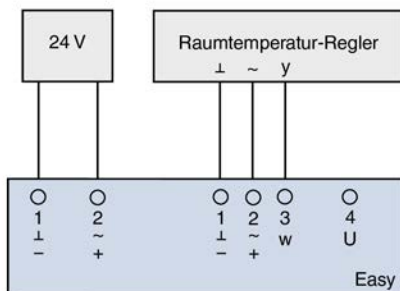

Fig. 15: Variable volume flow control

If the volume flow rate is to be specified by a higher-level controller (e. g. for room temperature, air quality or a DDC outstation), its 0–10 V DC output must be connected by at least 2 wires (terminals 1 and 3) to the terminals for the control signal (w) of the Easy controller in accordance with the connection diagram. With a common 24 V supply voltage, it should be noted that terminal 1 on the Easy controller is also the ground for the control signal.

Switching the volume flow rate V_{min}/V_{max}

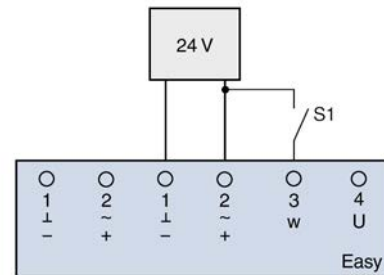

Fig. 16: Switching the volume flow rate V_{min}/V_{max}

If the volume flow rate between two constant values can be switched (i. e., day/night switching), it is possible to switch over between the volume flow rate setpoint values specified by the V_{min} and V_{max} potentiometers using an on-site volt-free switch contact.

Switch S1 open - V_{min}

Switch S1 closed - V_{max}

Parallel connection

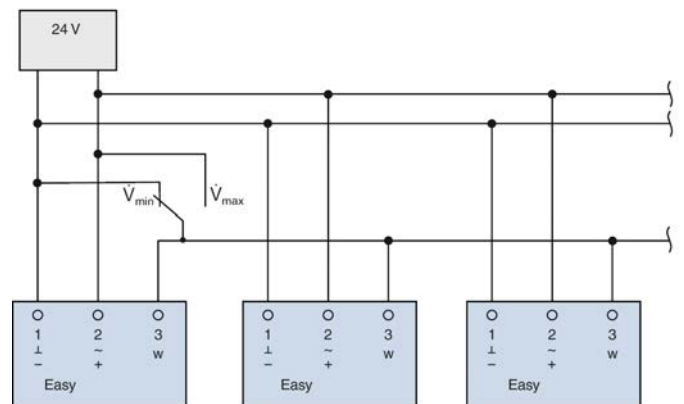

Fig. 17: Parallel connection

If several Easy controllers are to be switched simultaneously with a switch contact between V_{min} and V_{max} , the switch S1 must be designed as a changeover switch, and the contact for V_{min} operation must be connected to the ground (terminal 1)

Override control on/off

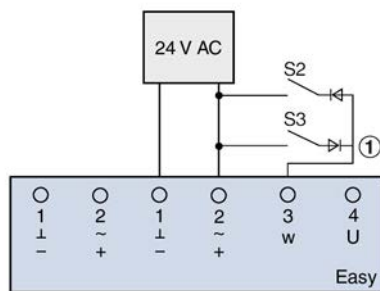

Fig. 18: Override control

When using a 24 V AC supply voltage, special operating states, so-called override controls, can alternatively be activated.

For this purpose, it is necessary to have a different circuit with a diode circuit and volt-free switch contacts, provided by others.

Switch S2 closed - CLOSED (closed position)

Switch S3 closed - OPEN (open position)

Note: this functionality is only available with AC supply voltage.

All override controls can be combined both with each other and with the different switching options. When combining several override controls the switches must be interlocked to prevent short-circuits.

With activation of the override control "damper blade CLOSED", the VAV terminal unit is put into the closed position. Depending on the design of the VAV terminal unit, residual leaks may remain, or an air-tight shut-off can be achieved. For more detailed information, see technical data of the VAV terminal unit.

Control V_{\min} ... V_{\max} with 20 mA control signal

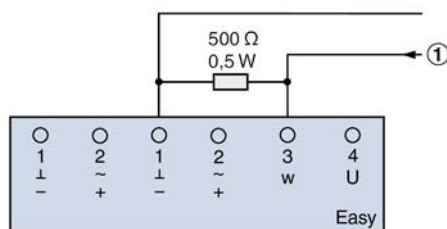

Fig. 19: Variable volume flow

The connection of a reference signal from 0 to 20 mA is also possible. For this purpose, a resistance of 500 Ω is placed between the ground and input (w). The actual value output (U) is always available as voltage signal 0–10 V DC.

6 Commissioning and operation

6.1 Setting the Easy controller



Fig. 20: Setting the volume flow rate setpoint values, for example LMV-D3A

- 1 V_{\min} potentiometer
- 2 V_{\max} potentiometer

The minimum or maximum volume flow rate is set via the potentiometer on the Easy controller. With these, depending on the control request, a constant volume flow rate corresponding to V_{\min} or the working range for the variable volume flow control can be set between V_{\min} and V_{\max} .

Further explanations and examples on the following pages.

6.1.1 Control ranges of VAV terminal units

Each VAV terminal unit with Easy controller has a sticker with the volume flow rate scale. Note the individual volume flow rate and control ranges of the respective combination of the VAV terminal unit and the control component.

The usable volume flow rate and control range is shown in the following table or on the scale sticker of the VAV terminal units, Fig. 21.

Type of VAV terminal units	Area of application	Easy controller types	Usable control range
LVC	low airflow velocity and low duct pressure	<ul style="list-style-type: none"> LMV-D3AL-F 227V-024T-05-013 	10...100%
TVE	low airflow velocity and low duct pressure	TROVE-024T-05I-DD15	4...100%
TVR	various applications in the standard volume flow rate range	<ul style="list-style-type: none"> LMV-D3A-F 227V-024T-05-002 	10...100%
TVJ	normal to high volume flow rate ranges	<ul style="list-style-type: none"> 227V-024T-15-002 	20...100%
TVT	normal to high volume flow rate ranges with air-tight shut-off	<ul style="list-style-type: none"> 227V-024T-15-002 SMV-D3A 	20...100%
TZ-SILENZIO	high acoustic requirements at low airflow velocity in the supply air area	<ul style="list-style-type: none"> LMV-D3A 	10...100%
TA-SILENZIO	high acoustic requirements at low airflow velocity in the extract air area	<ul style="list-style-type: none"> LMV-D3A 	10...100%
TVZ	high acoustic requirements in the supply air area	<ul style="list-style-type: none"> LMV-D3A 	10...100%
TVA	high acoustic requirements in the extract air area	<ul style="list-style-type: none"> LMV-D3A 	10...100%

6.1.2 Volume flow rate scale

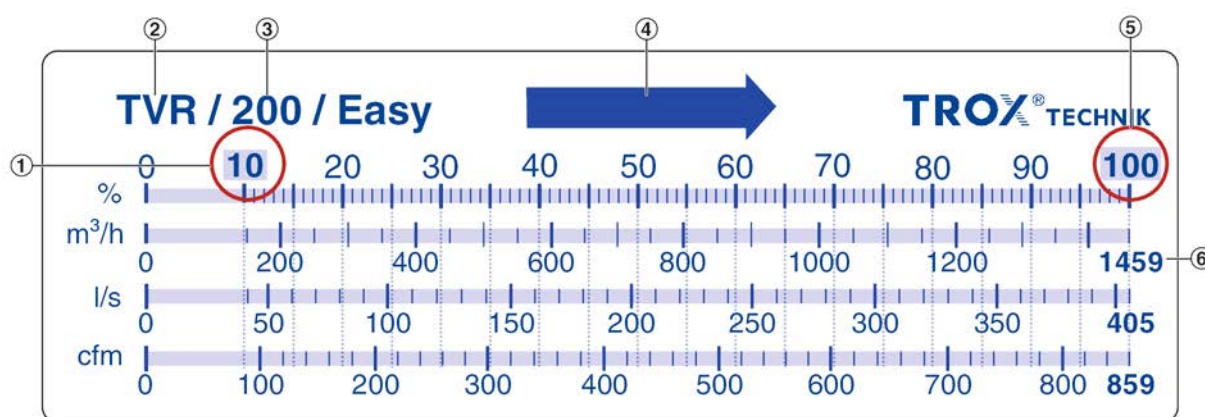

Fig. 21: Scale sticker example TVR/200/Easy

- | | |
|---------------------------------------|---|
| 1 Minimal adjustable volume flow rate | 4 Arrow indicating the airflow direction |
| 2 Type of controller, here e.g. TVR | 5 Maximum adjustable volume flow rate |
| 3 Nominal size | 6 Nominal volume flow rate in [m³/h], [l/s] and [cfm] |

The scale sticker serves as an aid for setting the volume flow control range. The scale is individual for the combination of control unit, nominal size and mounted control component.

The grey shaded percentages (1 and 5) document the usable control range of the respective VAV terminal unit type. The right edge of the scale at 100% documents the respective nominal volume flow rate in [m³/h], [l/s] and [cfm].

The percentages thus represent the ratio of the respective volume flow rate to the nominal volume flow rate.

6.1.3 Settings examples

Example 1: TVR / 200 / Easy

Nominal volume flow rate V_{nom} of the control unit - 1459 m³/h

Desired volume flow rate control range - V_{min} : 400 m³/h to V_{max} : 1000 m³/h

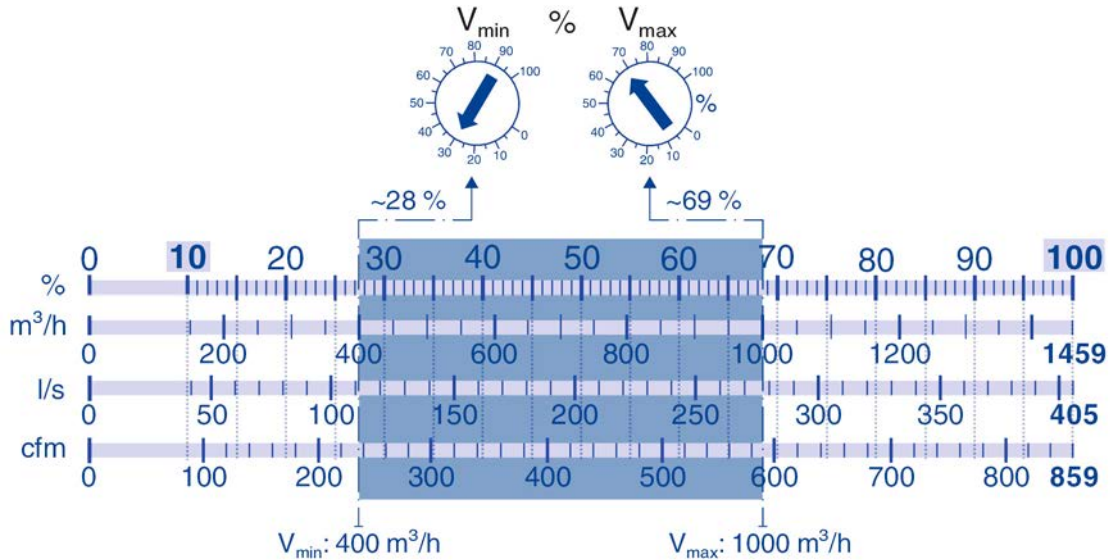

Billing solution:

$$V_{min}: 400 \text{ m}^3/\text{h} / 1459 \text{ m}^3/\text{h} \times 100 \approx 28\%$$

$$V_{max}: 1000 \text{ m}^3/\text{h} / 1459 \text{ m}^3/\text{h} \times 100 \approx 69\%$$

Example 2: TVJ / 400 x 200 / Easy

Nominal volume flow rate V_{nom} of the control unit - 2592 m³/h

Desired volume flow rate control range - V_{min} : 650 m³/h to V_{max} : 2250 m³/h

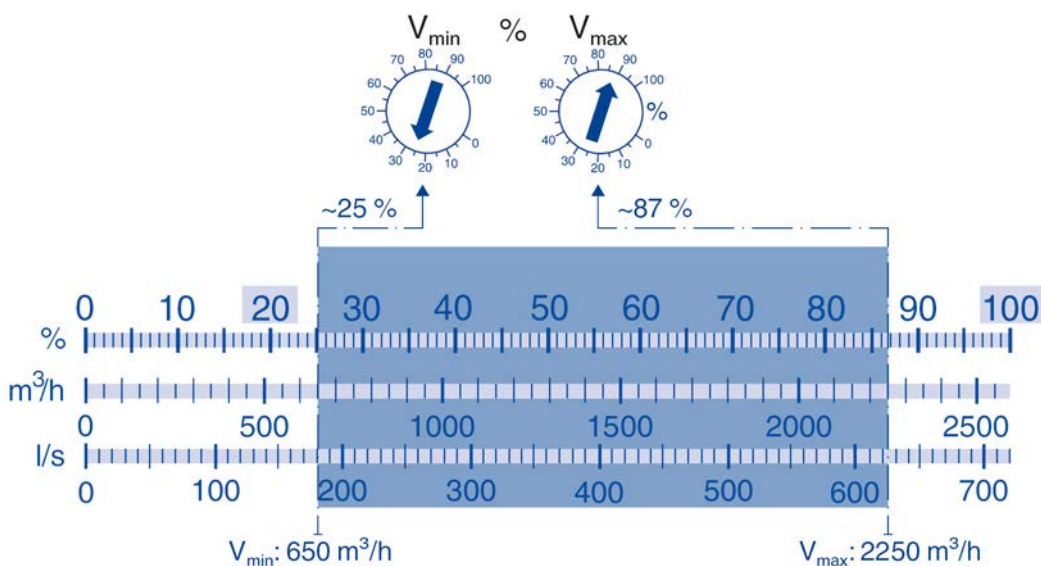

Billing solution:

$$V_{min}: 650 \text{ m}^3/\text{h} / 2592 \text{ m}^3/\text{h} \times 100 \approx 25\%$$

$$V_{max}: 2250 \text{ m}^3/\text{h} / 2592 \text{ m}^3/\text{h} \times 100 \approx 87\%$$

6.1.4 Default settings V_{\min} and V_{\max}

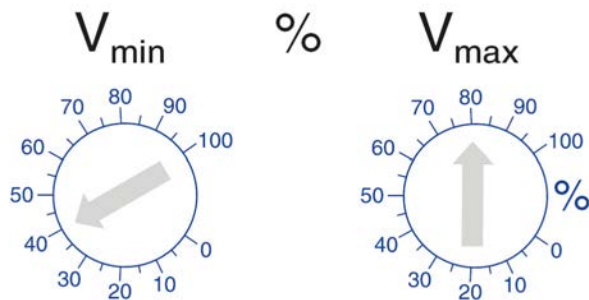

Default settings of the air terminal units with Easy controller:

- V_{\min} : 40%
- V_{\max} : 80%

During commissioning, the settings can be adjusted according to the requirements.

6.1.5 Setting constant volume flow control

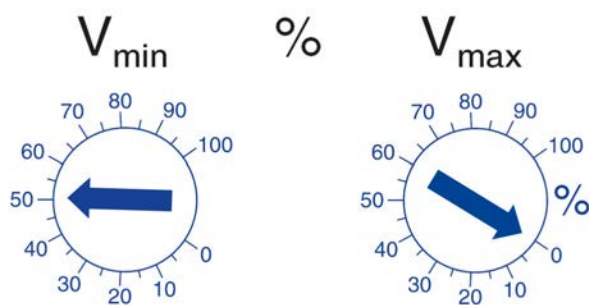

The setpoint value for a constant volume flow rate is set on the V_{\min} potentiometer.

The position of the V_{\max} potentiometer should be set to 0%.

For the constant volume flow control, no control signal is required at terminal w.

6.1.6 Setting variable volume flow control

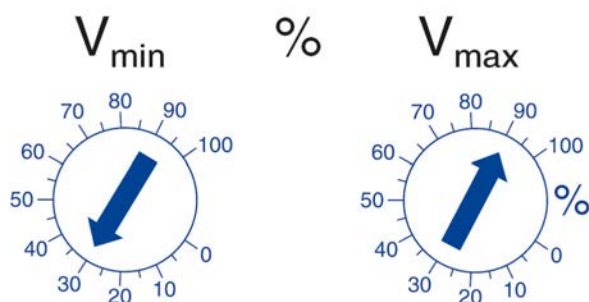

In the case of a variable volume flow control, the variable volume flow rate operating range is set via the potentiometers V_{\min} and V_{\max} , which is controlled via the control signal at terminal w.

The following points should be noted for the control input signal:

- Usable control range of the VAV terminal unit
↳ Chapter 6.1.1 'Control ranges of VAV terminal units' on page 22
- V_{\min} = nominal volume flow rate at control signal (w) with 0 V DC (not less than 10 or 20%)
- V_{\max} = set volume flow rate at control signal (w) with 10 V DC

In order to achieve a higher resolution of the assignment of 0–10 V voltage signals to the volume flow rate setpoint values, the operating range can be restricted.

If the value for V_{\min} is set higher than V_{\max} , the setting of V_{\min} is interpreted as a fixed setpoint value. The setpoint signal (w) is ignored here.

6.1.6.1 Setting the entire control range for the control input signal of the central building management system

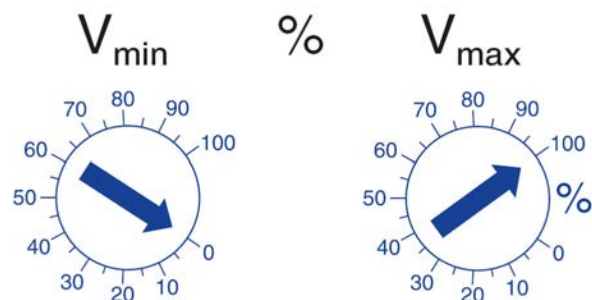

If the volume flow rate is to be specified by the central BMS over the entire control range, set the V_{\min} potentiometer to 0% and the V_{\max} potentiometer to 100%.

The following points should be noted for the control input signal:

- Usable control range of the VAV terminal unit
↳ Chapter 6.1.1 'Control ranges of VAV terminal units' on page 22
The usable control range is available from a 1 V DC or 2 V DC control signal, depending on the VAV terminal unit type.
- If the control signal drops below 0.5 V DC, the damper blade moves to the shut-off position. Compliance with a control signal ≤ 0.5 V DC is not always given due to interference voltages on the supply lines. Therefore, the positive circuit should always be preferred for a safe shut-off ↳ 'Override control on/off' on page 20.

6.2 Functional test

Personnel:

- Skilled qualified electrician
- HVAC technician

To perform a functional test, the Easy controller has a test push button, the operating states are displayed on the LED screen, ↪ *Chapter 3 'Structure and functional description' on page 10*

To check the function of the VAV terminal unit, check the position of the damper blade on the damper blade shaft (marked), [linktarget \[VVS-Regelgeräte-Stellung der Regelklappe\] doesn't exist but @y.link.required=true'](#).

Preparation:

- Switch on the power supply.
 - Switch on air conditioning system.
1. ▶ Press the test push button for approx. 1 second.
 - ⇒ Test function is started.
 - Actuator moves the damper blade to the CLOSED position.
 - Actuator moves the damper blade to the OPEN position.
 - Actuator moves the damper blade back to the control position.
 - When the set volume flow rate is reached, the LED lights up solidly.
 2. ▶ Override control V_{\min} on the master controller.
 - ⇒ Logging actual value signal U
 3. ▶ Override control V_{\max} on the master controller.
 - ⇒ Logging actual value signal U

- ⇒ The direction of rotation reversal is signalled by the LED flashing briefly.

The actuator then performs a synchronisation (slow flashing) and then returns to normal operation.

6.3 Switching the direction of rotation

Personnel:

- TROX Technical Service

Attention: only for service personnel – release by untrained personnel endangers the control function!

With volume flow rate deviations, an incorrect effect of actuator action (direction of rotation) of the controller could be the cause.

Test:

1. ▶ To test, disconnect the setpoint signal at terminal (w) and set the V_{\min} potentiometer to 0%.
 - ⇒ If the actuator then moves the damper blade to the OPEN position, the direction of rotation is set incorrectly.

Rotation direction reversal (not for TVE type):

2. ▶ Set V_{\min} and V_{\max} potentiometers to 100% each.
3. ▶ Press the test push button (at least 4 s).

7 Troubleshooting

Air terminal units with Easy controller are tested technically before delivery. Operating parameters must be set individually for each controller during commissioning to the required system conditions.

If faults occur after commissioning, they can usually be remedied yourself using the following descriptions.

If a fault cannot be remedied on its own, TROX Service will be happy to assist you with troubleshooting, simply contact ☎ 'TROX Technical Service' on page 3

For this, the following information is needed:

- Type and nominal size of VAV terminal unit (see adjustments sticker):
- V_{min}/V_{max} settings
- Control input signal

7.1 Common mistakes

7.1.1 Volume flow rate deviation due to unfavourable installation situation

If the desired volume flow rate value is not adhered to precisely enough, which is the most frequent cause of error, this creates an unfavourable installation situation of the VAV terminal unit.

If the straight inflow length upstream of the air terminal unit is too short, the airflow becomes turbulent and the measurement of the volume flow rate becomes inaccurate. This is especially true when installing behind sharp edged bridges, fittings or junctions. The necessary straight inflow lengths are specified in the installation and commissioning instructions of the VAV terminal unit.

7.1.2 Incorrect wiring

In many cases wiring errors are the cause of faults. For this reason, only the 24 V supply voltage should initially be connected when troubleshooting a volume flow controller.

1. ▶ If present, disconnect the connecting cables at the setpoint value input (terminal w) and the actual value output (terminal U). This switches off all external circuit influences.
2. ▶ Check if the 24 V supply voltage is switched on.
 - ⇒ When the supply voltage is switched on, the Easy controller attempts to set the volume flow rate to the setpoint value V_{min} .
3. ▶ Check whether the controller has reached the setpoint value.

The green LED must light up solid within approx. 180 seconds. In addition, the signal voltage of the actual value output (terminal U) can be measured with a voltmeter, ☎ 29

- ⇒ If the setpoint value is reached, the controller will work properly.

4. ▶ The test can be repeated for different setpoint values by adjusting the V_{min} potentiometer.

7.1.3 System pressure too low

The aim of the volume flow control is to regulate the volume flow rate actual value to the specified setpoint value.

Sufficient output by the fan is therefore needed so that the desired nominal volume flow rate can be set (throttled) with the control unit.

If the output in front of the control unit is too low (required minimum differential pressure not available), the setpoint value cannot be reached.

This can be detected on the damper blade shaft of the VAV terminal unit.

If the damper blade is still in the OPEN position with the setpoint signal present, instead of in a control position (throttle position), the volume flow rate is not high enough to set the setpoint value. The controller will try to open the damper blade further to reach the desired volume flow rate setpoint value.

7.1.4 Use outside the control area

If the device-specific control range is left with the potentiometer setting V_{min}/V_{max} , or with the specified setpoint signal, the setpoint values cannot be reached. The actual value reached by the controller is undefined.

Potentiometer adjustment and setpoint value control signal:

Depending on the control unit type, the voltage signal must be >1V or 2V, in particular, when setting $V_{min} = 0\%$ and $V_{max} = 100\%$, in order to control the valid control range.

Additional Information:

- ☎ Chapter 6.1.1 'Control ranges of VAV terminal units' on page 22
- ☎ Chapter 3.6 'Characteristics' on page 16

7.1.5 Deviation between setpoint value and actual value signal

Frequently, in the regulated state of the Easy controller, the same signal voltage is expected at the setpoint value input and the actual value output. However, this only applies in the event that a V_{min} of 0% and a V_{max} of 100% are set on the potentiometers, since the same characteristic curve vertices are used for the setpoint value input and the actual value output.

Furthermore, in the controlled state, due to the permissible control tolerance, small deviations between the signal voltages of the setpoint value and actual value can always be expected.

If the potentiometer settings for V_{\min} and V_{\max} restrict the usable control range, this will change the characteristic curve of the setpoint signal. Since the actual value signal is always assigned to a characteristic curve of 0 V_{nom} , a restriction of the usable control range results in a different characteristic curve for setpoint value and actual value signal.

In this case, a direct inference due to different signal voltages at the setpoint value input or actual value output without (rollover) calculation is not possible.

7.2 Systematic troubleshooting

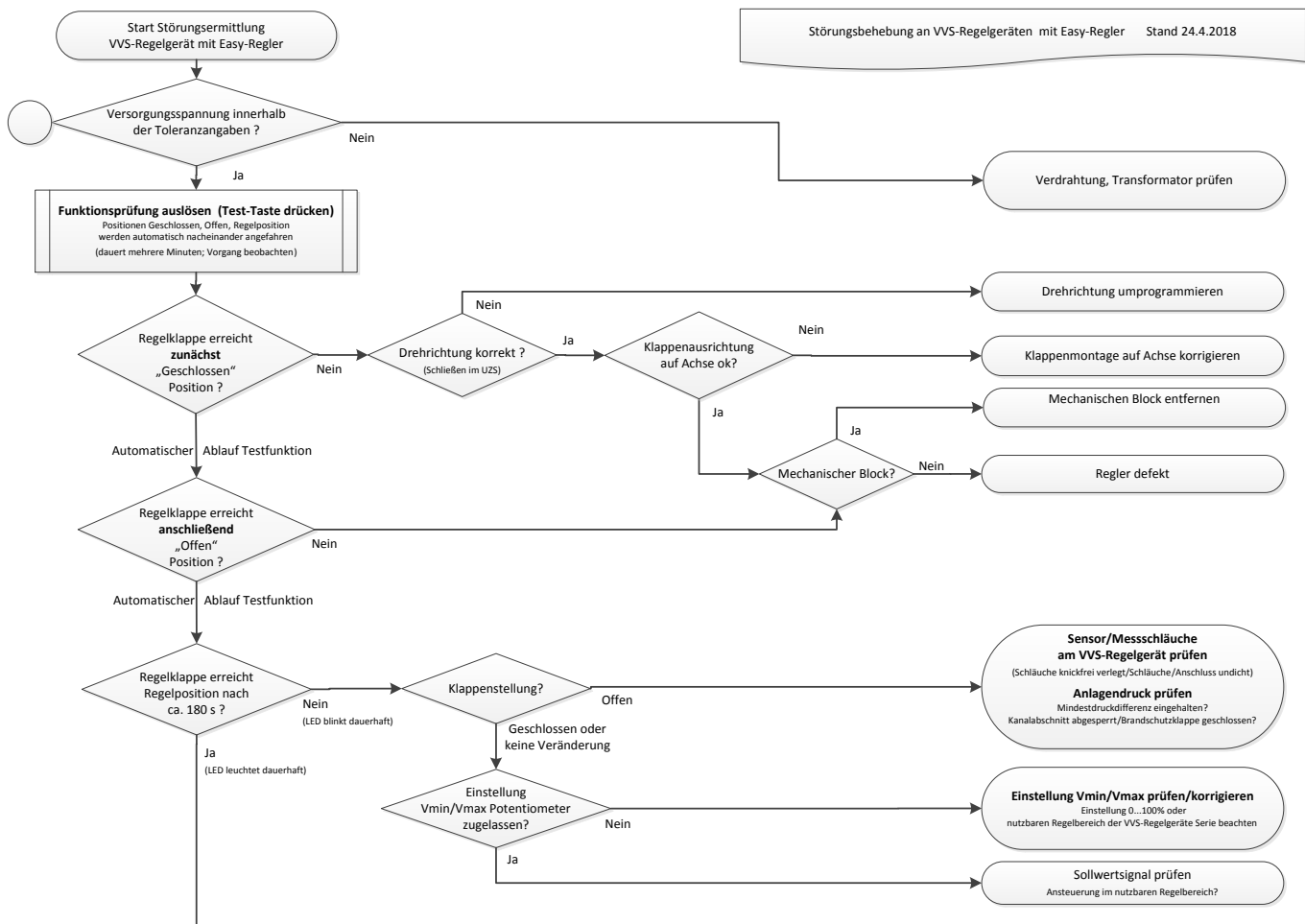

Fig. 22: Troubleshooting Easy Controller V24.4.18 - Part 1

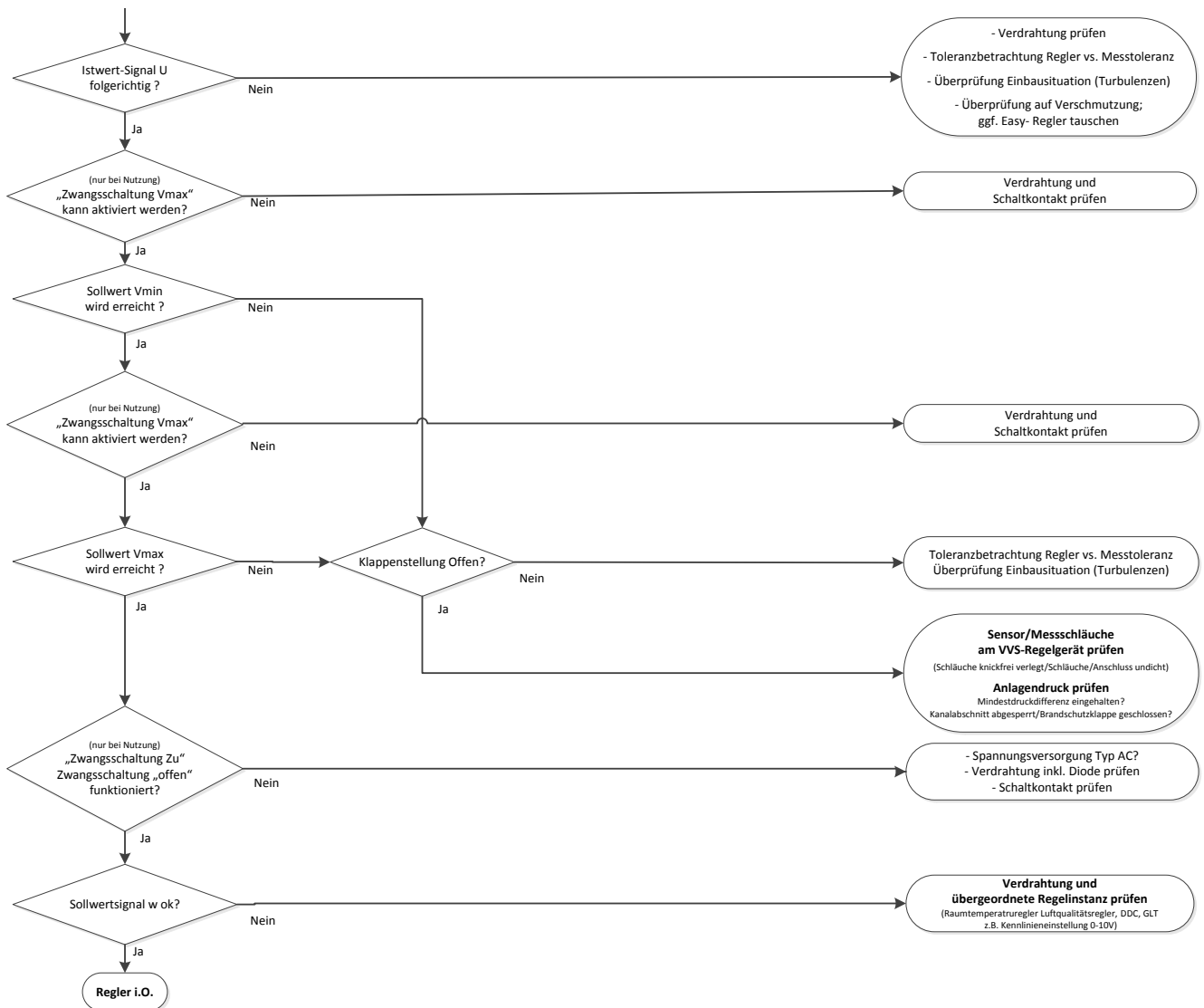

Fig. 23: Troubleshooting Easy Controller V24.4.18 - Part 2

7.3 Further diagnostic options

7.3.1 Use of voltmeters to control setpoint values and feedback signals

With a voltmeter, both the setpoint signal (terminal w against terminal 1) and the actual value signal (terminal U against terminal 1) can be measured electrically. Using the following formulas, the associated setpoint value and actual value volume flow rates can be calculated and thus checked:

$$\dot{V}_{\text{Soll}} = \frac{w}{10} (\dot{V}_{\text{max}} - \dot{V}_{\text{min}}) + \dot{V}_{\text{min}}$$

$$\dot{V}_{\text{Ist}} = \frac{U}{10} \dot{V}_{\text{Nenn}}$$

Note: depending on the selected setting on the V_{min} and V_{max} potentiometers, the setpoint value voltage and actual voltage may well be different, even if they are correctly regulated.

Example 1: TVR 400 / Easy

Nominal volume flow rate V_{nom}	- 6030 m ³ /h
Setting V_{min}	- 0%
Setting V_{max}	- 100%
Voltage terminal w	- 5.14 V
Voltage terminal U	- 5.35 V

Billing solution:

$$V_{\text{ref}}: 5.14 \text{ V} / 10 \text{ V} \times (6030 \text{ m}^3/\text{h} - 0 \text{ m}^3/\text{h}) + 0 \text{ m}^3/\text{h} = \underline{3099 \text{ m}^3/\text{h}}$$

$$V_{\text{actual}}: 5.3 \text{ V} / 10 \text{ V} \times 6030 \text{ m}^3/\text{h} = 3226 \text{ m}^3/\text{h}$$

$$\text{Deviation} = 3226 - 3099 = 127 \text{ m}^3/\text{h} \approx 4\%$$

Example 2: TVR 400 / Easy

Nominal volume flow rate V_{nom}	- 6030 m ³ /h
Setting V_{min}	- 40%
Setting V_{max}	- 80%
Voltage terminal w	- 8.24 V
Voltage terminal U	- 6.93 V

Billing solution:

$$V_{ref}: 8.24 \text{ V} / 10 \text{ V} \times (0.8 \times 6030 \text{ m}^3/\text{h} - 0.4 \times 6030 \text{ m}^3/\text{h}) + 0.4 \times 6030 \text{ m}^3/\text{h} = 4399 \text{ m}^3/\text{h}$$

$$V_{actual}: 6.93 \text{ V} / 10 \text{ V} \times 6030 \text{ m}^3/\text{h} = 4179 \text{ m}^3/\text{h}$$

$$\text{Deviation} = 4179 - 4399 = -220 \text{ m}^3/\text{h} \approx -5\%$$

Example of order information: replacement controller type Easy for VAV terminal unit TZ-SILENZIO in dimension 200: TZ-SILENZIO 200 / Easy

Note: for some VAV terminal unit types, Easy replacement controllers can be used regardless of the dimensions of the basic units.

This only applies to types TVR, TVJ, TVT, TVZ.

Examples: a replacement controller for the TVJ/Easy type can be used both on the nominal width of 300x100 and on all other dimensions of the TVJ. A TVR/Easy replacement controller can be used on the 250, as well as all other dimensions of the TVR.

7.3.2 Use of adjustment devices

The use of an adjustment device is not permitted for the Easy controllers. Depending on the delivery period and factory preparation, the values displayed on the control component cannot be clearly assigned as for the original equipment or for substitute controllers.

7.3.3 Adjustments sticker

The adjustments sticker documents the factory testing, the settings and the most important order data of the VAV terminal unit and the control component.

TROX GmbH
Heinrich-Trox-Platz
D-47504 Neukirchen-Vluyn

TROX® TECHNIK

COM:000000000.0001.248

TYP:TVT / 700x200 / Easy

OP :0-10V / Vmin-Vmax poti setup

LIM:V:4523 m³/h /CCW(i) C:382

HW :227V-024T-15-002 /SP

SN :#160803145159-4

ID :DE.2.01.2017234.0024

Fig. 24: Adjustments sticker

The information is required as part of the technical support provided by the TROX service or for the ordering of replacement parts.

7.3.4 Ordering replacement controllers

When ordering an Easy replacement controller, the device type and nominal width/dimensions are required when ordering. Customer-specific operating values for Easy controllers are not set at the factory. The information can be found, for example, in the adjustments sticker described in the previous chapter.

8 Disposal

After final decommissioning, the air terminal unit with the control component type Easy must be disposed of properly by a competent authority. The device contains electrical and electronic components and must not be disposed of as domestic waste. When disposed of, local up to date regulations must be complied with.

9 Technical data

General operating conditions of the control components

Ambient temperature	10-50 °C
Ambient humidity	5-90% rF

VAV terminal units	Type	Part number
LVC	LMV-D3AL-F	M466EU1
	227V-024T-05-013	M466EU2
TVE	TROVE-024T-05I-DD15	A00000069228
TVR	LMV-D3A-F	M466ES1
	227V-024T-05-002	M466DC3
TVJ, TVT ¹⁾	227V-024T-15-002	A00000053055
TVT ²⁾	SMV-D3A	M466ES3
TZ-Silenzio, TA-Silenzio, TVZ, TVA	LMV-D3A	M466ES2

1) Type TVJ all dimensions of type TVT up to dimension 1000x500

2) Type TVT all dimensions specified from H>500

Easy controller LMV-D3AL-F

	Supply voltage ~	24 V AC ± 20%, 50/60 Hz
	Supply voltage ≡	24 V DC -10/+20%
	Power rating ~	3.5 VA max.
	Power rating ≡	Max. 2 W
	Run time for 90°	120 – 150 s
	Setpoint value signal input	0 – 10 V DC, Ra > 100 kΩ
	Actual value signal output	0 – 10 V DC, max. 0.5 mA
	IEC protection class	III (protective extra-low voltage)
	Protection level	IP 20
EC conformity	EMC to 2014/30/EU	

Easy controller 227V-024T-05-013



Supply voltage ~	24 V AC \pm 20%, 50/60 Hz
Supply voltage =	24 V DC \pm 20 %
Power rating ~	5 VA max.
Power rating =	Max. 3 W
Run time for 90°	100 s
Setpoint value signal input	0 – 10 V DC, Ra > 100 k Ω
Actual value signal output	0 – 10 V DC, max. 0.5 mA
IEC protection class	III (protective extra-low voltage)
Protection level	IP 20
EC conformity	EMC to 2014/30/EU

Easy controllers LMV-D3A and LMV-D3A-F



Supply voltage ~	24 V AC \pm 20%, 50/60 Hz
Supply voltage =	24 V DC -10/+20%
Power rating ~	5 VA max.
Power rating =	Max. 2.5 W
Run time for 90°	110 – 150 s
Setpoint value signal input	0 – 10 V DC, Ra > 100 k Ω
Actual value signal output	0 – 10 V DC, max. 0.5 mA
IEC protection class	III (protective extra-low voltage)
Protection level	IP 20
EC conformity	EMC to 2014/30/EU

Easy controller 227V-024T-05-002



Supply voltage ~	24 V AC \pm 20%, 50/60 Hz
Supply voltage =	24 V DC \pm 20%
Power rating ~	5 VA max.
Power rating =	Max. 3 W
Run time for 90°	100 s
Setpoint value signal input	0 – 10 V DC, Ra > 100 k Ω
Actual value signal output	0 – 10 V DC, max. 0.5 mA
IEC protection class	III (protective extra-low voltage)
Protection level	IP 20
EC conformity	EMC to 2014/30/EU

Easy controller 227V-024T-15-002

Supply voltage ~	24 V AC ± 20%, 50/60 Hz
Supply voltage ≡	24 V DC ± 20%
Power rating ~	5 VA max.
Power rating ≡	Max. 3 W
Run time for 90°	150 – 270 s
Setpoint value signal input	0 – 10 V DC, Ra > 100 kΩ
Actual value signal output	0 – 10 V DC, max. 0.5 mA
IEC protection class	III (protective extra-low voltage)
Protection level	IP 20
EC conformity	EMC to 2014/30/EU

Easy controller SMV-D3A

Supply voltage ~	24 V AC ± 20%, 50/60 Hz
Supply voltage ≡	24 V DC –10/+20%
Power rating ~	6 VA max.
Power rating ≡	Max. 3 W
Run time for 90°	110 – 150 s
Setpoint value signal input	0 – 10 V DC, Ra > 100 kΩ
Actual value signal output	0 – 10 V DC, max. 0.5 mA
IEC protection class	III (protective extra-low voltage)
Protection level	IP 20
EC conformity	EMC to 2014/30/EU

Easy controller TROVE-024T-05I-DD15

Supply voltage ~	24 V AC ± 20%, 50/60 Hz
Supply voltage ≡	24 V DC –10/+20%
Power rating ~	4 VA max.
Power rating ≡	Max. 2.5 W
Run time for 90°	100 s
Setpoint value signal input	0 – 10 V DC, Ra > 100 kΩ
Actual value signal output	0 – 10 V DC, max. 0.5 mA
IEC protection class	III (protective extra-low voltage)
Protection level	IP 42
EC conformity	EMC to 2014/30/EU

10 Declaration of conformity

We hereby declare that the Easy controller complies with all relevant provisions of the following EC guidelines:

- Directive 2014/30/EU
- Directive 2014/35/EU
- Directive 2011/65/EU

The individual CE certificates can be found at www.trox.de.

TROX[®] TECHNİK

The art of handling air

TROX GmbH
Heinrich-Trox-Platz
47504 Neukirchen-Vluyn
Germany

+49 (0) 2845 202-0
+49 (0) 2845 202-265
E-mail: trox@trox.de
www.troxtechnik.com

© TROX GmbH 2018